

Installation instructions, accessories - Installation kit child seat

Volvo Car Corporation Göteborg, Sweden



XC90

Section	Group	Weight(Kg/Pounds)	Year	Month
8	88		2002	09

XC90 2003, XC90 2004, XC90 2005, XC90 2006, XC90 2007, XC90 2008, XC90 2009, XC90 2010

Replaces issue: 2002 01

Installation instructions, accessories - Installation kit child seat

Volvo Car Corporation Göteborg, Sweden



Required tools

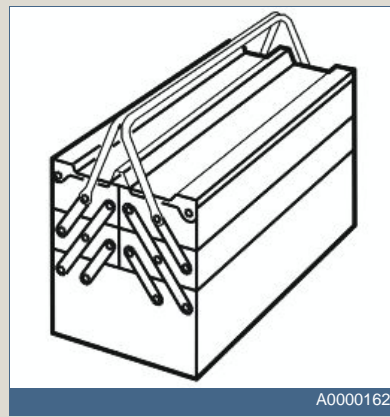

A0000162

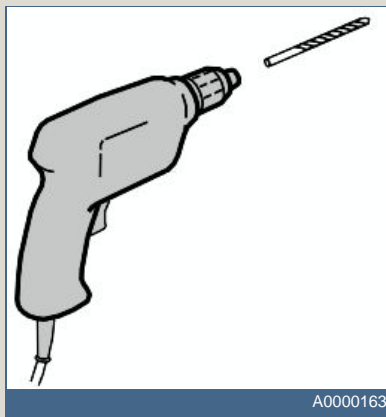

A0000163



Nm
lbf.ft

A0000161

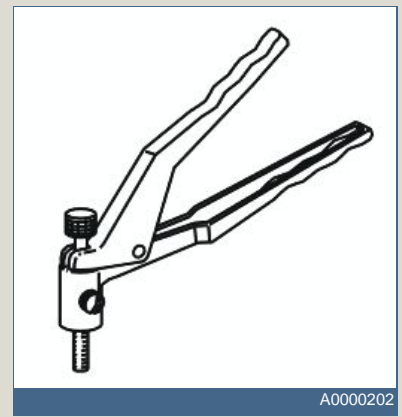

A0000202

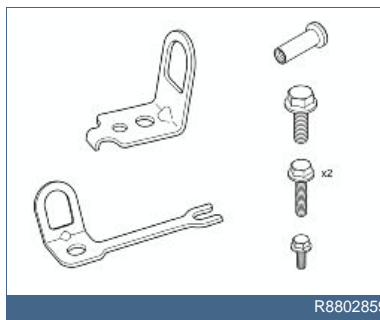

R8802859

Any comments on this publication? Please contact your nearest dealer. Thank you!

Publication no: MA 8622788, Issue: 2002-09
Comments:.....
.....
.....
.....
.....
.....
.....
From:.....
Address:.....
Telephone no:.....
Telefax:.....



INTRODUCTION

- **NOTE! Read through the whole installation instruction before starting the work.**
- The front page gives the date of this edition and the edition it replaces
- The second page shows the tools needed for the installation and the contents of the installation kit
- The illustrations display the procedure in order of operation. The order of operation is repeated in the text section
- Cut out the text page in order to follow the illustrations and text at the same time.

Installation kit child seat

Warning!

This installation kit must NOT be mounted on the front seat on the passenger side in cars equipped with Supplemental Restraint System Module (SRS) (airbag). Child seats must NOT be mounted in the front seat on the passenger side in cars equipped with Supplemental Restraint System Module (SRS) (airbag).

Note!

It is recommended that this installation is carried out at a Volvo workshop.

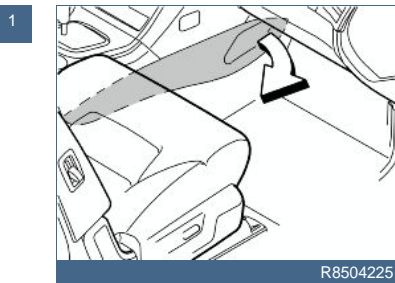

Preparations

- Remove the right-hand side panel from the centre console by pulling it off. Start at the front edge and then work backwards until all the clips have released.

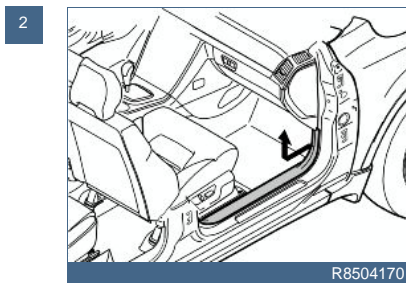

Preparations

- Remove the sill trim panel for the right-hand front door. Pull it off, starting at the front edge, until the clip there has released. Continue backwards until the remaining clips have released
- Move the sill trim panel to the right in order to fold the carpet away from the right-hand side of the bodywork.

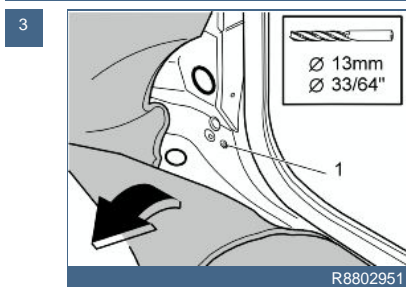

Installing the right-hand mounting

- Push the floor carpet to one side
- Enlarge the existing hole (1) in the bodywork. Use a **13 mm (33/64")** diameter drill bit
- Smooth off and rust-proof the edges of the hole.

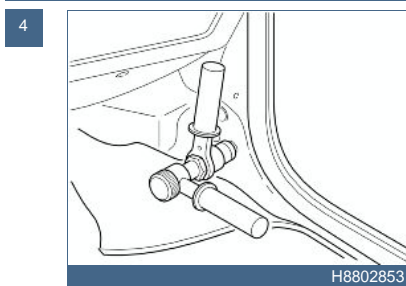

Installing the right-hand mounting

- Take the rivet nut from the kit. Place the rivet nut on the rivet nut tool (P/N 9512782). Install the rivet nut in the drilled hole using the tool. Secure the rivet nut to the bodywork.

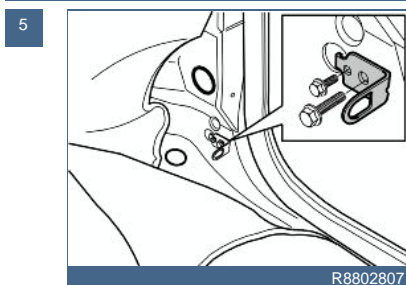

Installing the right-hand mounting

- Take the mounting and the M10 and M6 screws from the kit. Secure the mounting to the rivet nut. Secure the weld nut in the bodywork. Tighten the M10 screw. Tighten to **50 Nm (37 lbf. ft.)**. Tighten the M6 screw. Tighten to **10 Nm (7 lbf. ft.)**
- If the car has a passenger compartment connector socket, its bracket must be positioned above the mounting. Secure using the M6 screw.



6

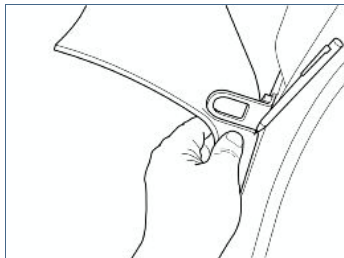

H8802854

Installing the right-hand mounting

- Fold back the carpet under the mounting. Using a pen, mark on the carpet the position of the lower edge of the mounting eyelet.

7

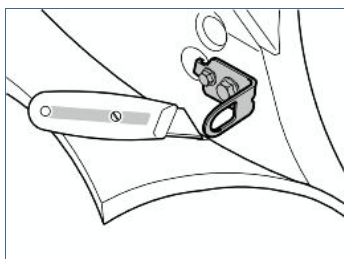

R8802809

Installing the right-hand mounting

- Use a carpet knife. Cut vertically upwards from the marked point. Cut equal to the width of the mounting eyelet.

8

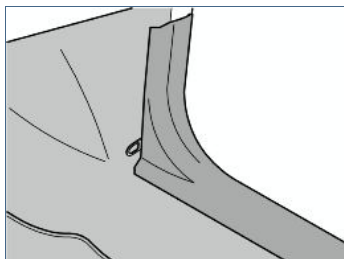

R8802810

Installing the right-hand mounting

- Fold back the carpet. Reinstall the sill trim panel.

9

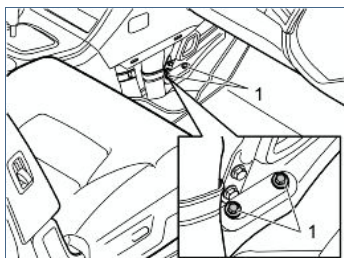

R8802811

Installing the left-hand mounting

- Push the floor carpet to one side where the side panel was removed
- Remove the two screws (1) in front of the air duct. Place the screws to one side. They will not be used again. There are new screws in the kit.

10

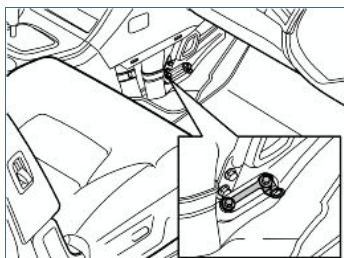

R8802858

Installing the left-hand mounting

- Take the mounting and two M8 screws from the kit. Secure the mounting to the bodywork. Tighten the screws. Tighten to **24 Nm (18 lbf. ft.)**.



11



R8802812

Installing the left-hand mounting

- Fold back the carpet under the mounting. Using a pen, mark where the mounting eyelet is to go through the carpet.

12

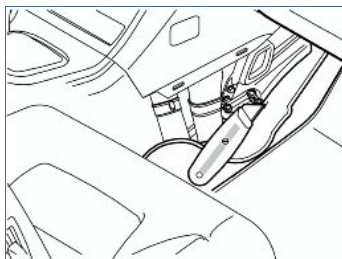

R8802814

Installing the left-hand mounting

- Use a carpet knife. Make a cut in the carpet directly in front of the marking. Make the cut as wide as the mounting eyelet.

13

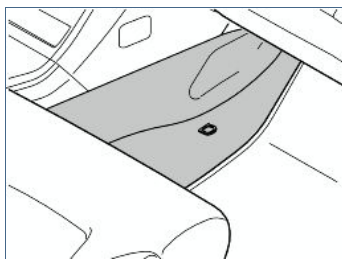

R8802815

Installing the left-hand mounting

- Fold the carpet back into place
- Reinstall the right-hand side panel on the centre console.