

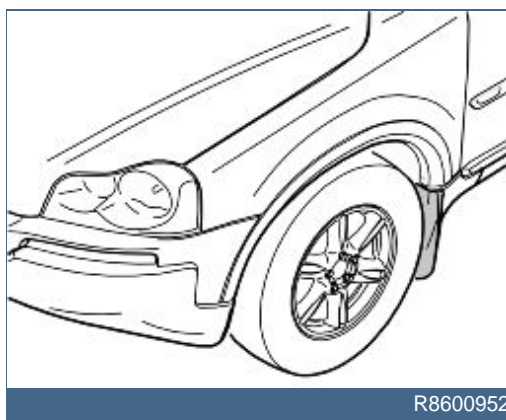

XC90

Section	Group	Weight(Kg/Pounds)	Year	Month
8	86		2001	12

XC90 2003, XC90 2004, XC90 2005, XC90 2006, XC90 2007, XC90 2008, XC90 2009, XC90 2010



Installation instructions, accessories - Mudguard front

Volvo Car Corporation Göteborg, Sweden



Required tools

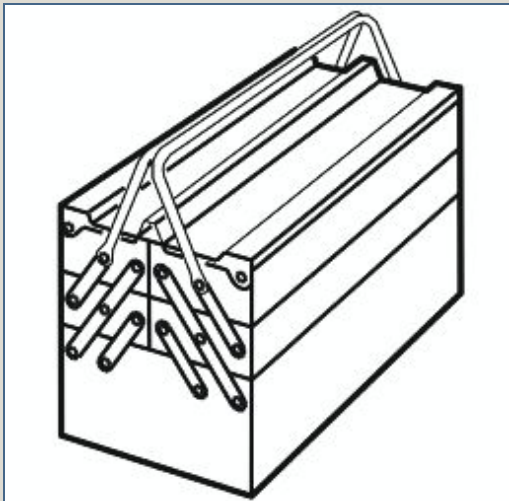

A0000162

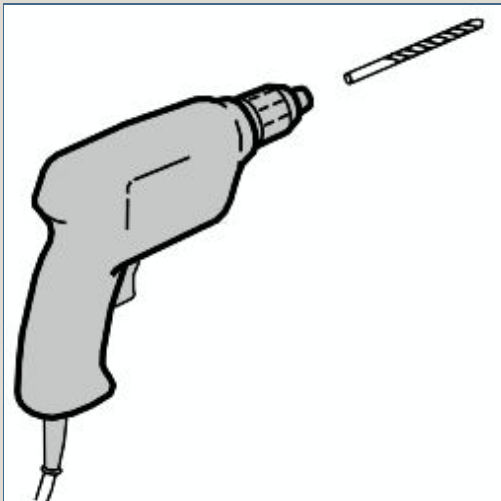

A0000163

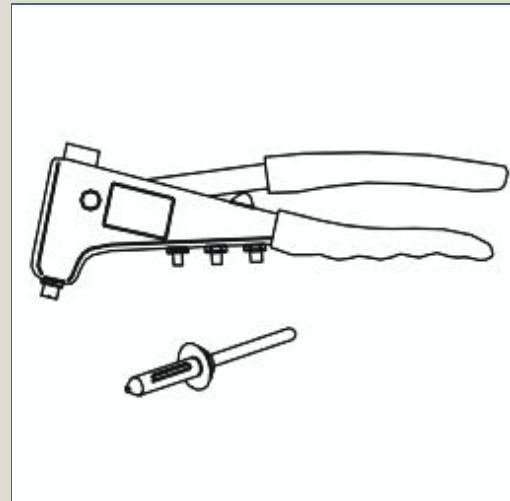

A0000172

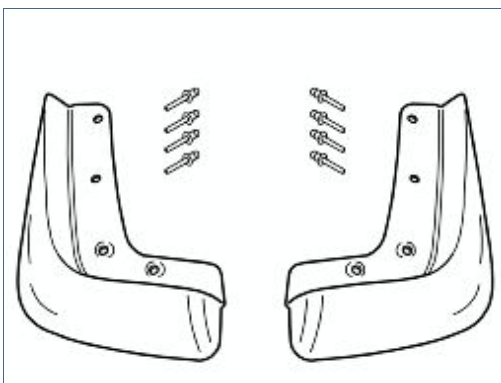

R8600951

Any comments on this publication? Please contact your nearest dealer. Thank you!

Publication no: MA 8685558, Issue: 2001-12
Comments:.....
From:.....
Address:.....
Telephone no:.....
Telefax:.....





INTRODUCTION

Mudguard front

- **NOTE! Read through the whole installation instruction before starting the work.**
- The front page gives the date of this edition and the edition it replaces
- The second page shows the tools needed for the installation and the contents of the installation kit
- The illustrations display the procedure in order of operation. The order of operation is repeated in the text section
- Cut out the text page in order to follow the illustrations and text at the same time.



1

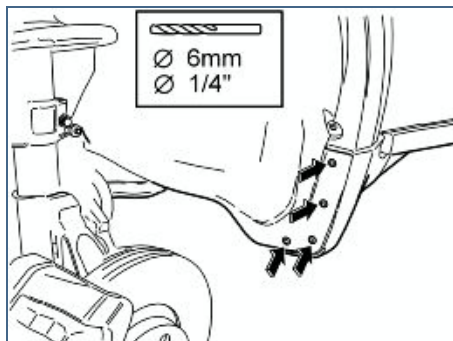

R8600949

- Remove the front wheels
- Carefully drill out the four rivets holding the bumper liner at the rear edge of the front fender. Use a 6 mm (1/4") diameter drill bit
- Remove any rivet swarf.

Note!

Do not damage any of the plastic components.

2

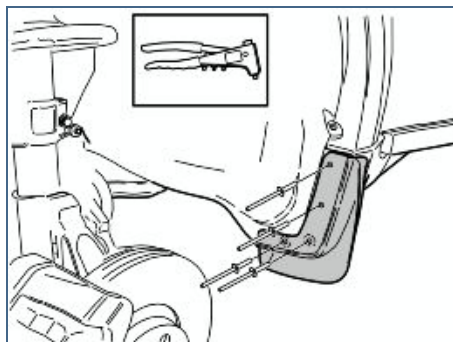

R8600950

- Install the mudguard. Rivet the mudguard into place in the bumper liner and the rear edge of the bumper cover
- Reinstall the front wheels. Tighten the wheels. Tighten to **140 Nm (103 lbf. ft)**.